

FORM A

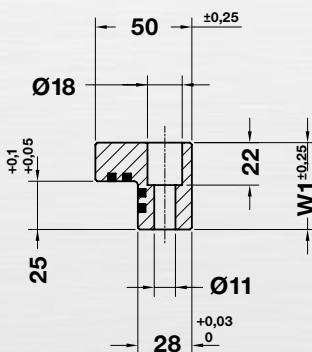

FORM B

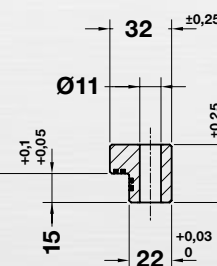

FORM C

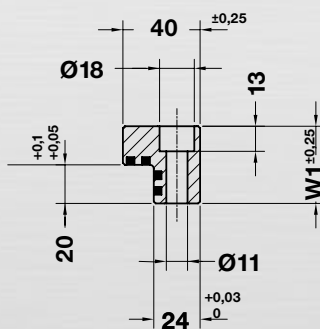

FORM D

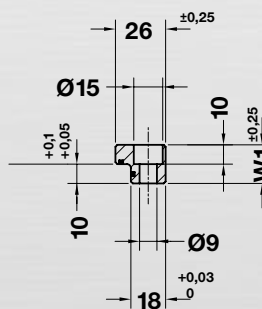

MATERIAL	DUREZA/HARDNESS
	CUERPO/BODY
Bronce + Grafito Bronze + Graphite	HB > 190

W1	L1	L2	L3	L4	L5	L6	L7	Form
20	100	20	80	-	-	-	9	D
20	150	20	75	130	-	-	9	D
20	200	20	75	125	180	-	9	D
30	100	20	80	-	-	-	11	B
30	150	20	75	130	-	-	11	B
30	200	20	75	125	180	-	11	B
30	250	20	90	160	230	-	11	B
40	160	15	145	-	-	-	12	C
40	250	15	145	225	-	-	12	C
45	200	20	75	125	180	-	14	A
45	250	20	90	160	230	-	14	A
45	300	20	85	150	215	280	14	A
45	350	20	100	175	250	330	14	A

Forma de pedido/ How to order:
EBGW W1 x L1

ESCUADRA BRONCE + GRAFITO EBGW

ANGULAR BRONZE + GRAPHITE GUIDE EBGW



VDI 3357

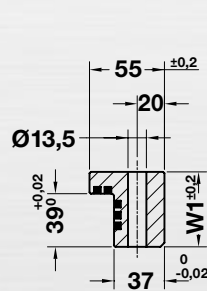
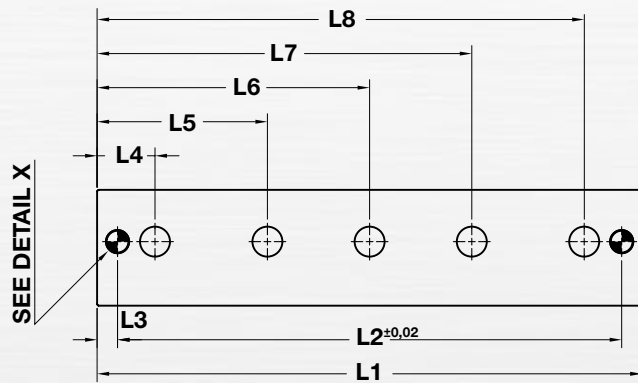

FORM A

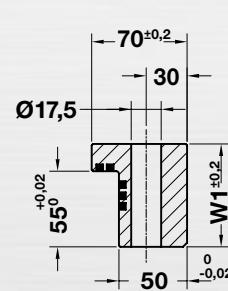

FORM B

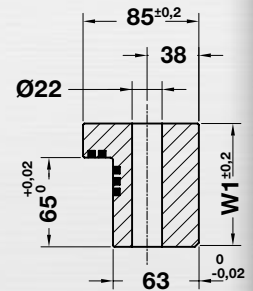

FORM C

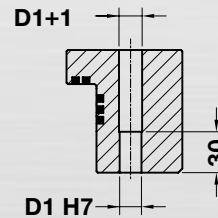

FORM A ÷ C
DETAIL X

MATERIAL	DUREZA/HARDNESS
	CUERPO/BODY
Bronce + Grafito Bronze + Graphite	HB > 190

W1	L1	L3	L2	L4	L5	L6	L7	L8	D1	Form
55	100	10	80	27,5	-	-	-	72,5	10	A
55	160	10	140	27,5	-	-	-	132,5	10	A
75	160	12,5	135	35	-	-	-	125	12	B
75	200	12,5	175	35	-	-	-	165	12	B
75	250	12,5	225	35	-	125	-	215	12	B
75	400	12,5	375	35	125	200	275	365	12	B
90	160	15	130	42,5	-	-	-	117,5	16	C
90	200	15	170	42,5	-	-	-	157,5	16	C
90	250	15	220	42,5	-	125	-	207,5	16	C
90	400	15	370	42,5	125	200	275	357,5	16	C

Forma de pedido/ How to order:
EBGW W1 x L1