

CÁNCAMO GIRATORIO CGN SWIVEL EYEBOLT WITH RING CGN

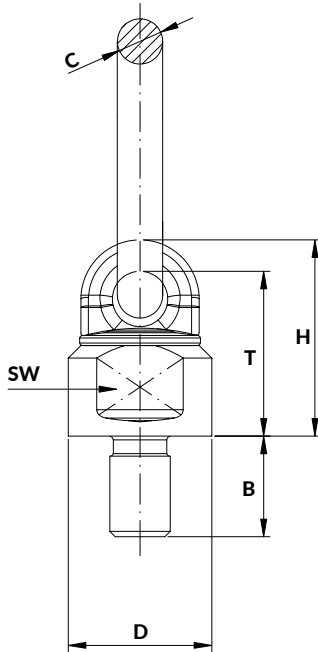









STOCK



CE 2006/42/CE

M	B	MAIN DIMENSIONS (mm)						RING SIZE	WEIGHT (Kg)
		D	C	H	SW	T			
M8	13	36	17	53	22	45	13 x 50 x 30	0,40	
M10	18	36	17	53	22	45	13 x 50 x 30	0,40	
M12	18	36	17	53	22	45	13 x 50 x 30	0,40	
M14	20	36	17	53	22	45	13 x 50 x 30	0,40	
M16	20	36	17	53	22	45	13 x 50 x 30	0,40	
M20	30	50	19	68	30	57	16 x 70 x 34	0,90	
M24	30	57	22	78	34	66	18 x 85 x 40	1,40	
M27	35	57	22	78	34	66	18 x 85 x 40	1,50	
M30	35	66	24	97	40	81	20 x 85 x 40	2,20	
M30	35	80	27	112	46	90	22 x 115 x 50	3,60	
M36	50	80	27	112	46	90	22 x 115 x 50	3,70	
M39	50	80	27	112	46	90	22 x 115 x 50	4,30	
M42	50	80	27	112	48	90	22 x 115 x 50	4,10	
M48	50	80	27	112	48	90	22 x 115 x 50	4,30	
M56	84	120	46	168	70	135	32 x 155 x 70	11,40	
M64	96	120	46	168	70	140	34 x 140 x 70	12,80	

CÁNCAMO GIRATORIO CGN SWIVEL EYEBOLT WITH RING CGN

Reference	0°	90°	0°	90°	0-45°	45-60°	0-45°	45-60°	Asymmetry	Asymmetry
										
	1 piece		2 pieces		2 pieces		3-4 pieces		2 pieces	3-4 pieces
MAX. WORKING LOAD (t)										
M8	0,60	0,30	1,20	0,60	0,42	0,30	0,63	0,45	0,30	0,30
M10	1	0,50	2	1	0,70	0,50	1,05	0,75	0,50	0,50
M12	1	0,50	2	1	0,70	0,50	1,05	0,75	0,50	0,50
M14	2,24	1,12	4	2,24	1,56	1,12	2,35	1,68	1,12	1,12
M16	2,24	1,12	4	2,24	1,56	1,12	2,35	1,68	1,12	1,12
M20	4	2	8	4	2,80	2	4,20	3	2	2
M24	6,40	3,20	12,80	6,40	4,48	3,20	6,72	4,80	3,20	3,20
M27	6,40	3,20	12,80	6,40	4,48	3,20	6,72	4,80	3,20	3,20
M30	10	5	20	10	7	5	10,50	7,50	5	5
M30	12	8	24	16	11,20	8	16,80	12	8	8
M36	12	8	24	16	11,20	8	16,80	12	8	8
M39	12	8	24	16	11,20	8	16,80	12	8	8
M42	15	10	30	20	14	10	21	15	10	10
M48	15	10	30	20	14	10	21	15	10	10
M56	22,50	15	45	30	21	15	31,50	22,50	15	15
M64	22,50	15	45	30	21	15	31,50	22,50	15	15

How to order: CGN + M
For M30 specify 5 or 8 T